



US00D560267S

(12) **United States Design Patent**
Header et al.

(10) **Patent No.:** **US D560,267 S**

(45) **Date of Patent:** **** Jan. 22, 2008**

(54) **FISHING REEL LEG**

(75) Inventors: **Gregory A. Header**, Richland, PA (US); **Timothy A. Wiest**, Hegins, PA (US)

(73) Assignee: **Innovative Reel Technologies**, Myerstown, PA (US)

(**) Term: **14 Years**

(21) Appl. No.: **29/262,957**

(22) Filed: **Jul. 14, 2006**

(51) **LOC (8) CL.** **22-05**

(52) **U.S. CL.** **D22/141**

(58) **Field of Classification Search** D22/141, D22/140, 137; 242/223-224, 230-235, 370, 242/311, 322, 242-246; 43/4, 22, 18.1, 19, 43/20, 19.2, 25

See application file for complete search history.

(56) **References Cited**

U.S. PATENT DOCUMENTS

2,711,292 A 6/1955 Taggart et al. 242/237

(Continued)

Primary Examiner—Catherine R. Oliver

(74) *Attorney, Agent, or Firm*—Shlesinger, Arkwright & Garvey LLP

(57) **CLAIM**

The ornamental design for the fishing reel leg, as shown and described.

DESCRIPTION

FIG. 1 is a perspective view of the fishing reel leg according to the present invention with the fishing reel shown in phantom lines;

FIG. 2 is a side elevational view of FIG. 1 with a portion of the phantom lines shown;

FIG. 3 is a front elevational view of FIG. 1;

FIG. 4 is a top plan view of FIG. 1;

FIG. 5 is a rear elevational view of FIG. 1;

FIG. 6 is a bottom plan view of FIG. 1;

FIG. 7 is a perspective view of another embodiment of the fishing reel leg according to the present invention with the fishing reel shown in phantom lines;

FIG. 8 is a side elevational view of FIG. 1 with a portion of the phantom lines shown;

FIG. 9 is a front elevational view of FIG. 1;

FIG. 10 is a top plan view of FIG. 1;

FIG. 11 is a rear elevational view of FIG. 1;

FIG. 12 is a bottom plan view of FIG. 1;

FIG. 13 is a perspective view of a further embodiment of the fishing reel leg according to the present invention with the fishing reel shown in phantom lines;

FIG. 14 is a side elevational view of FIG. 1 with a portion of the phantom lines shown;

FIG. 15 is a front elevational view of FIG. 1;

FIG. 16 is a top plan view of FIG. 1;

FIG. 17 is a rear elevational view of FIG. 1;

FIG. 18 is a bottom plan view of FIG. 1;

FIG. 19 is a perspective view of a still further embodiment of the fishing reel leg according to the present invention with the fishing reel shown in phantom lines;

FIG. 20 is a side elevational view of FIG. 1 with a portion of the phantom lines shown;

FIG. 21 is a front elevational view of FIG. 1

FIG. 22 is a top plan view of FIG. 1;

FIG. 23 is a rear elevational view of FIG. 1; and,

FIG. 24 is a bottom plan view of FIG. 1.

The broken line showing of environment in the drawings is included for the purpose of illustrating only and forms no part of the claimed design.

1 Claim, 4 Drawing Sheets

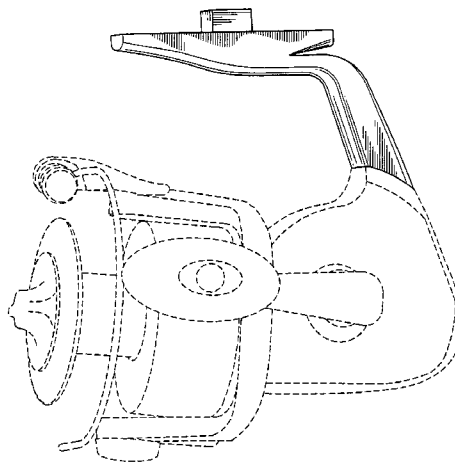

US D560,267 S

Page 2

U.S. PATENT DOCUMENTS

2,751,165 A	6/1956	Small	242/234	D324,092 S	2/1992	Baugh et al.	D22/141
2,925,229 A	2/1960	Wood	242/231	D329,271 S	9/1992	Shiozaki	D22/141
2,926,450 A	3/1960	Ritchie	43/22	5,237,770 A	8/1993	Creek	43/22
2,929,579 A	3/1960	Hull	242/238	D374,908 S *	10/1996	Koelewyn	D22/141
3,564,752 A	2/1971	Catignani	43/22	D401,663 S	11/1998	Henriksson et al.	D22/141
D300,236 S *	3/1989	Johansson et al.	D22/137	D414,237 S *	9/1999	Kang et al.	D22/141
4,815,228 A	3/1989	Abel	43/22	D500,354 S *	12/2004	Iwabuchi	D22/141
4,905,399 A	3/1990	Hopps	43/20	7,004,416 B1 *	2/2006	Hong	242/311
D309,171 S	7/1990	Hiraishi et al.	D22/141	2002/0027177 A1 *	3/2002	Barker	242/244
D309,936 S	8/1990	Hiraishi et al.	D22/141	2004/0108399 A1 *	6/2004	Sugawara	242/322

* cited by examiner

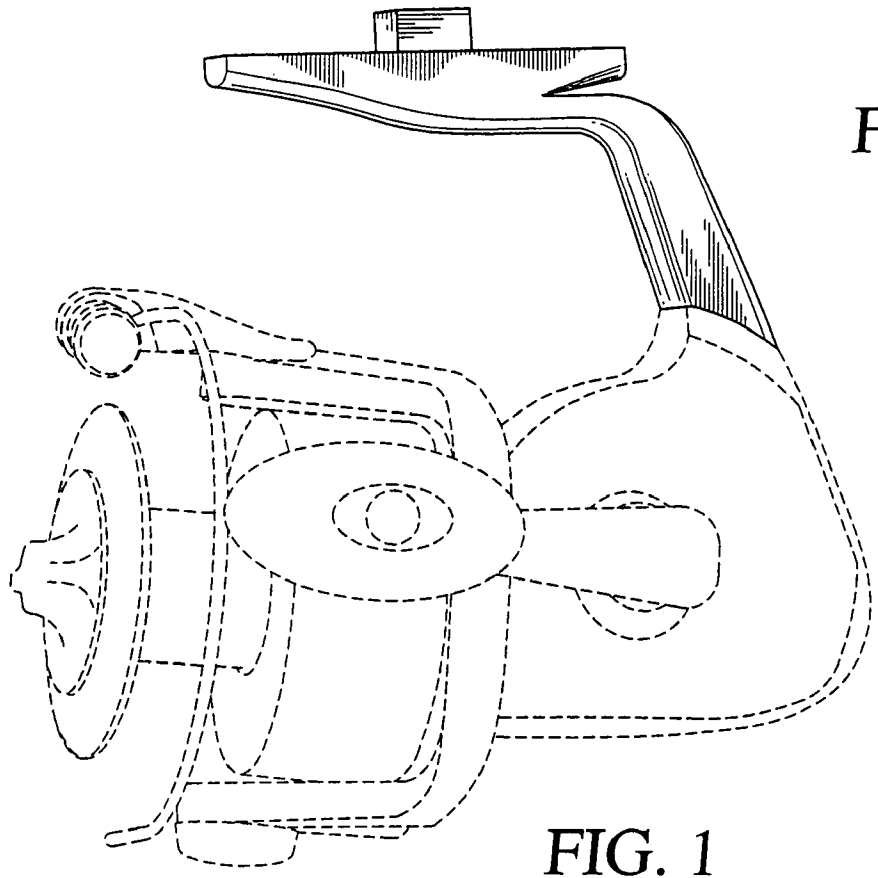

FIG. 1

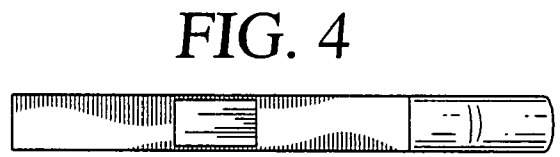

FIG. 4

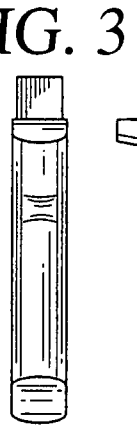

FIG. 3

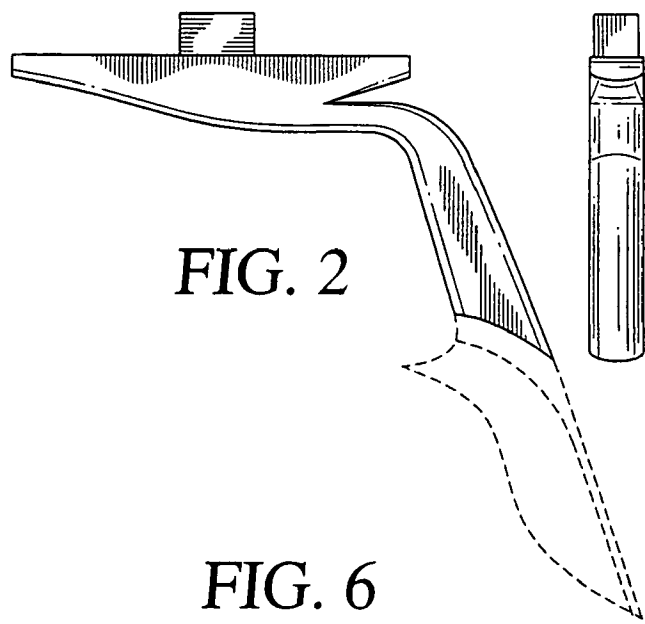

FIG. 2

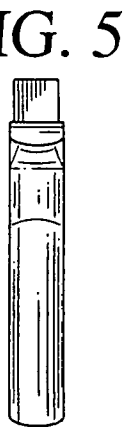

FIG. 5



FIG. 6

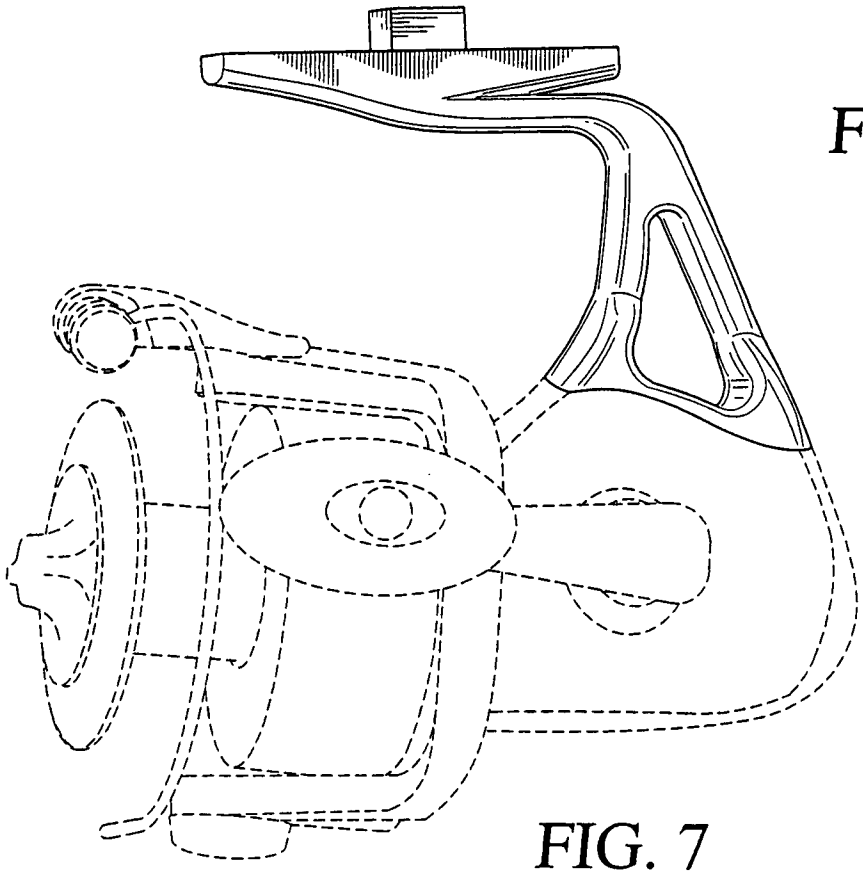

FIG. 10

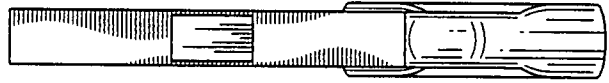

FIG. 9



FIG. 11



FIG. 8

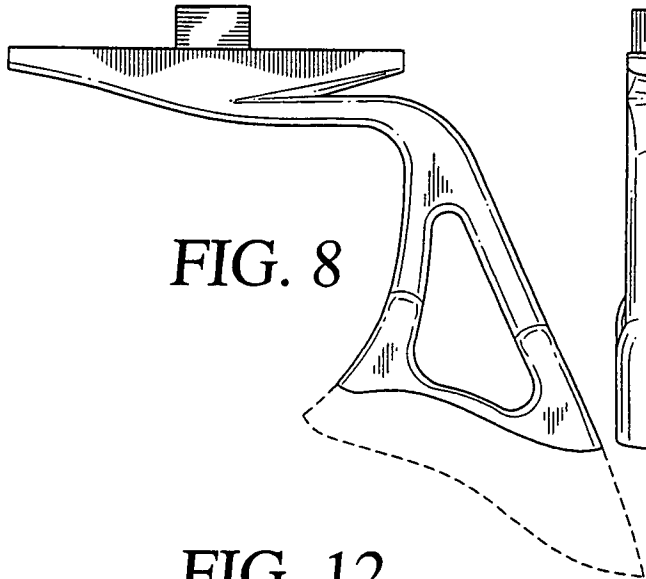

FIG. 12



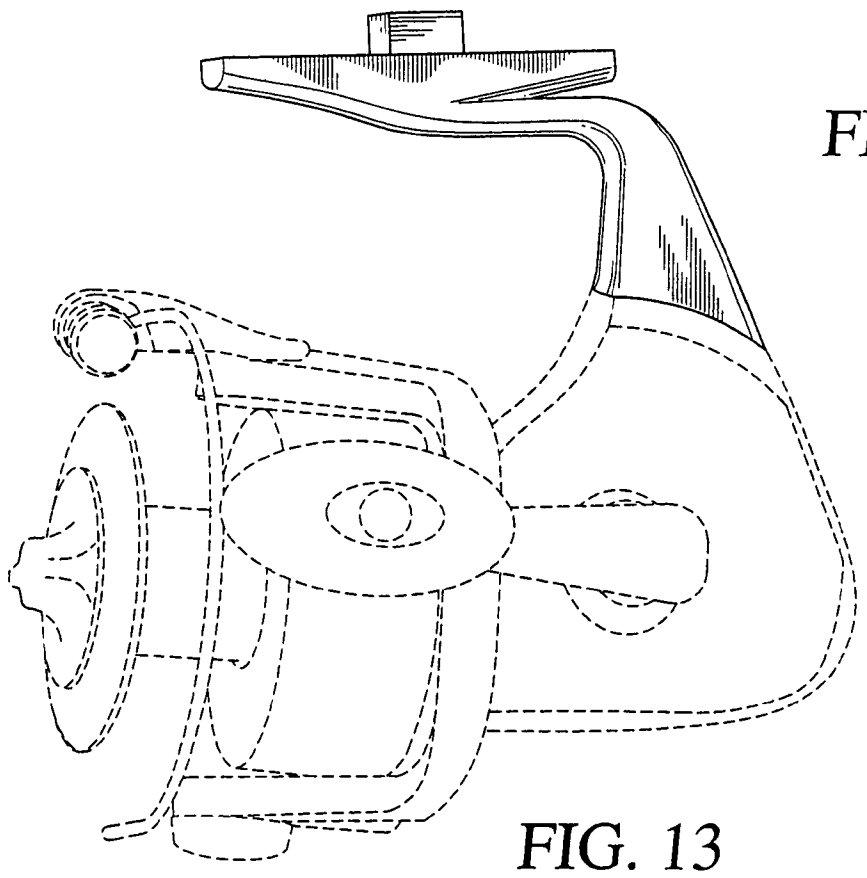

FIG. 13

FIG. 15



FIG. 16

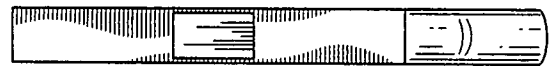

FIG. 17

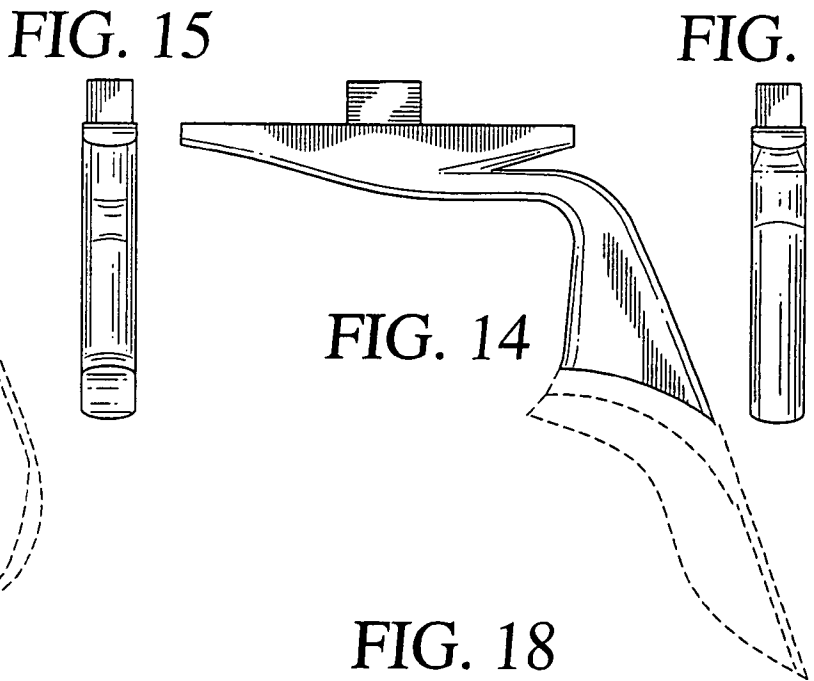
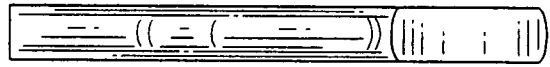

FIG. 14

FIG. 18



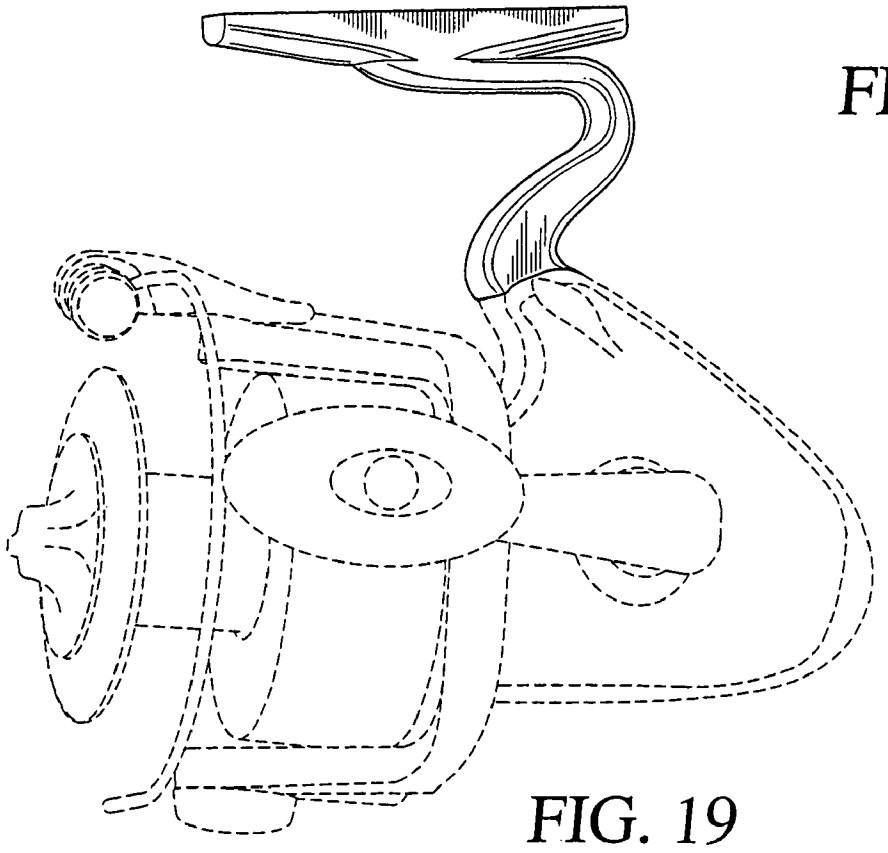

FIG. 19

FIG. 21

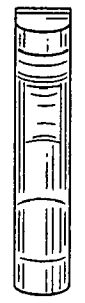

FIG. 22



FIG. 23

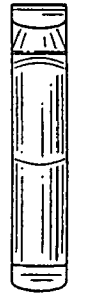

FIG. 20

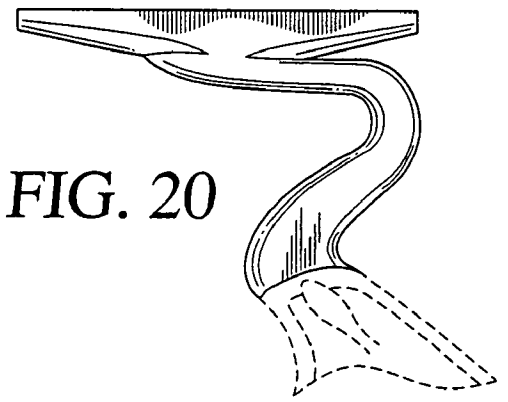

FIG. 24

